



**Russell Hobbs**

**WASHING MACHINE  
INSTRUCTION MANUAL**



**Model numbers:  
RH1247B, RH1247S & RH1247W**

Please read these instructions carefully and  
keep them for future reference

## THE CONTENTS

### **SECTION 1: BEFORE USING**

- Safety warnings
- Recommendations

### **SECTION 2: INSTALLATION**

- Removal of transportation screws
- Adjustment of feet
- Electrical connection
- Water supply connection
- Water drain connection

### **SECTION 3: TECHNICAL SPECIFICATIONS**

### **SECTION 4: LAUNDRY PREPARATION**

### **SECTION 5: CONTROL PANEL**

- Detergent drawer
- Programme knob
- Electronic display

### **SECTION 6: OPERATING YOUR MACHINE**

- Selecting programme
- Auxiliary functions
- Starting the programme
- Adding/Removing laundry
- Child lock
- Cancelling programme
- Finishing programme

### **SECTION 7: ELECTRONIC DISPLAY WARNING SYMBOLS**

- Warning of water cut-off/low mains water pressure
- Warning of clogged pump filter

### **SECTION 8: MAINTENANCE AND CLEANING**

- Water inlet filters
- Pump filter
- Detergent drawer
- Siphon plug
- The cabinet
- The drum
- Remove of your machine from lime

### **SECTION 9: PRACTICAL INFORMATION**

### **SECTION 10: TROUBLESHOOTING**

### **SECTION 11: AUTOMATIC FAULT WARNINGS AND WHAT TO BE DONE**

### **SECTION 12: DESCRIBING AND SAVING ENERGY**

## SECTION-1: BEFORE USING

### SAFETY WARNINGS

- Do not use multiple receptacles or extension cord.
- Do not plug in damaged or torn plugs.
- In case of a breakdown of power cable, contact the nearest authorized service for replacing it.
- Never pull the cable when unplugging. Grab the plug when unplugging.
- Do not plug-in or pull-out the plug from the receptacle with wet hands to prevent electric shock.
- Never touch the machine with your wet or damp hand or foot.
- Never open the detergent compartment when the appliance is running.
- Never force the door to open when the washing machine is running.
- Do not touch discharging hose and water during discharging as the appliance may reach high temperatures when running.
- In case of any breakdown, unplug the appliance first and then turn the water faucet off. Do not attempt to repair by yourself, instead consult authorized service.
- Remember that packaging materials of your machine may be dangerous for children. Keep the packaging materials in a place where children cannot reach or dispose of them as to wasting instructions.
- Do not allow your children to play with the washing machine as it is an electrically-driven appliance.
- Keep your pets away from your machine.
- Your machine should only be used by adults in line with the information provided in this user's manual.
- Your machine is designed to be used domestically. Commercial use will cause your warranty to be cancelled.
- Anyone's intervention to your machine except authorized services in anyway will cause your warranty to be invalid.
- Ideal operating temperature of your machine is 15-25°C.
- Do not deploy your machine on carpet and suchlike grounds that shall block ventilation of the base.
- Do not keep inflammable liquids near your machine.

## SECTION-1: BEFORE USING

- You should absolutely remove the transport screws of your machine before the first usage. Faults occurring in machines operated with transport screw fitted shall not be covered by the warranty.
- Do not put the discharging hose of your machine in a vessel, bucket or sink.
- Your machine is out of warranty against faults caused by any kind of external factors (spate, pesticides, fire, etc.).
- The appliance is not intended for use by people (including children) with reduced physical, sensory or mental capabilities, or lack of experience and knowledge unless they have been given supervision or instruction concerning use of the appliance by a person responsible for their safety. Children should be supervised to ensure that they do not play with the appliance.

### RECOMMENDATIONS

- Before beginning to use your washing machine, ask for free-of-charge help about installing, commissioning and using your washing machine by calling the nearest authorized service.
- **It is recommended to perform the first washing operation in 95° White Cotton programme and without laundry by inserting ½ scale of detergent into the 2<sup>nd</sup> compartment of the detergent drawer.**
- As detergent or softener exposed to air for a long time may cause residues, put your detergent or softener in the detergent drawer in the beginning of each washing.
- It is recommended that you wash only extremely dirty laundry in prewashing programme.
- The amount of laundry you put in your washing machine shall not exceed the maximum amount indicated.
- If your machine is not going to be used for a long time you should unplug the appliance, turn off the water inlet faucet and leave the door slightly open. This is so that the inside of your machine will remain dry and will not cause an unpleasant smell of damp.
- Some water may be left in your machine due to experiments and tests carried out during production. This will not damage your machine.

## SECTION-2: INSTALLATION

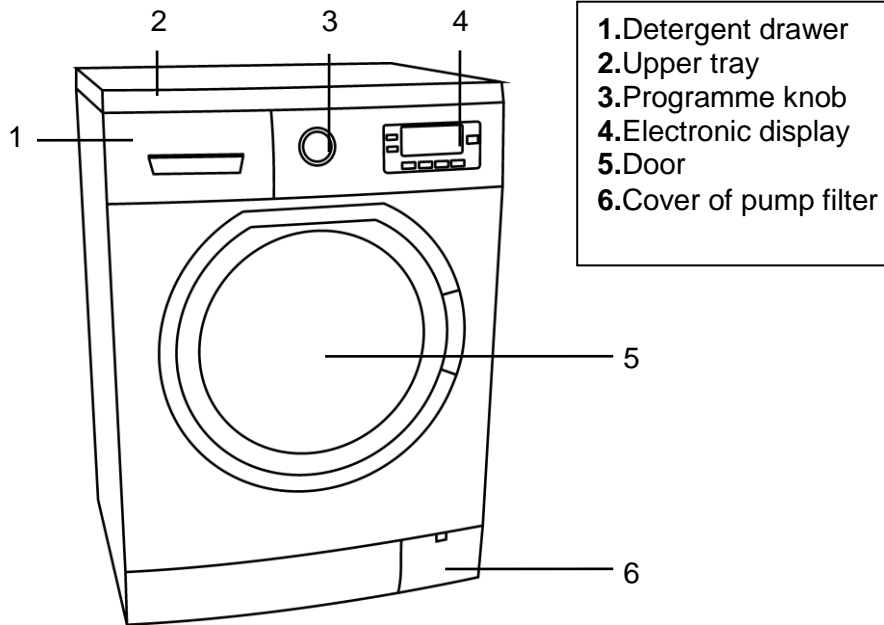

- 1. Detergent drawer
- 2. Upper tray
- 3. Programme knob
- 4. Electronic display
- 5. Door
- 6. Cover of pump filter

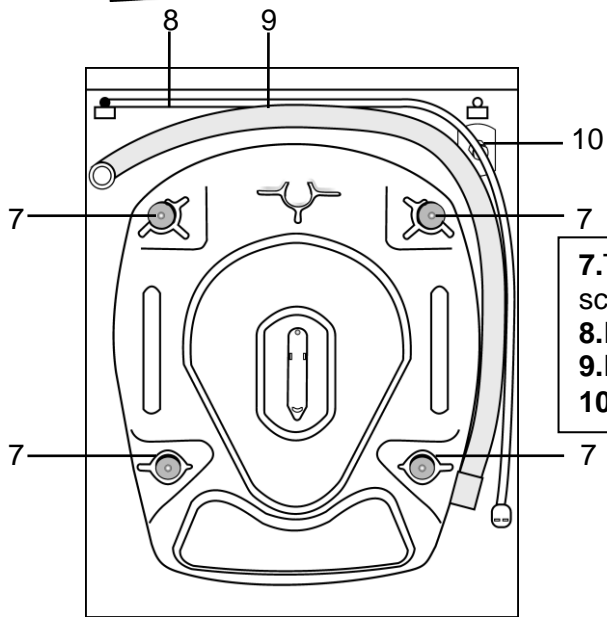

- 7. Transport safety screw
- 8. Power cable
- 9. Discharging hose
- 10. Water inlet valve

## SECTION-2: INSTALLATION REMOVING TRANSPORT SAFETY SCREWS

Transportation screws, which are located at the back of the machine, must be removed before using or running the machine.

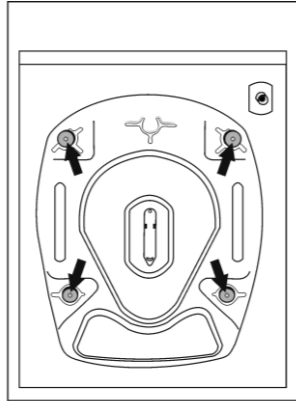

Loosen the screws by rotating counterclockwise with a suitable wrench.

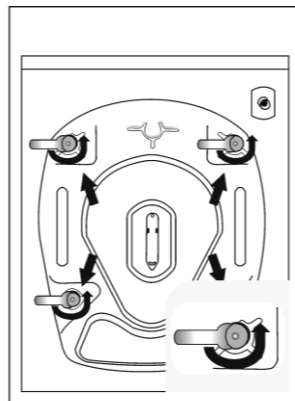

Pull out the screws together with the coloured plastic spacer, (the screws that have been removed from the machine should be kept for any other transportation necessities).

To seal the holes insert the supplied plastic caps

## SECTION-2: INSTALLATION ADJUSTMENT OF FEET

- Do not install your machine on a carpet or suchlike grounds.
- For your machine to work silently and without any vibration, it should be settled on a flat, non-slippery and tough ground.
- Loosen the plastic adjustment nut.

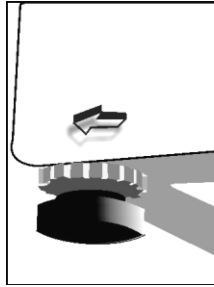

- Adjust the stays upward and downward by rotating them.

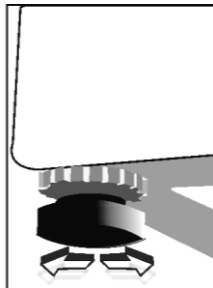

- When the correct balance has been achieved, tighten the plastic adjustment nut again by rotating it upwards.
- Never put cardboard, wood or suchlike materials under your machine to try and stabilize the distortions of the ground.

## SECTION-2: INSTALLATION ELECTRICAL CONNECTION / WATER INLET CONNECTION

### Electrical connection

- Your washing machine is set to 220-240V and 50Hz.
- Mains cord of your washing machine is equipped with a specific grounded plug. This plug should always be inserted to a grounded receptacle of 10 amps. Fuse current value of the power line connected to this plug should also be 10 amps. If you don't have such a receptacle and fuse confirming with this, please have it done by a qualified electrician.
- **We do not take responsibility for the damages that occur due to ungrounded usage.**
- Operating your machine under low voltage will cause the life cycle of your machine to be reduced and its performance to be restricted.

### Water inlet connection

- Your machine has a single water (cold) inlet.
- To prevent leakages on the connection joints, 1 seal is included in the hose packing, (Fit this seal on the end of the water inlet hose at the tap side.)
- Connect the bracketed end of the water inlet hose to the water inlet valve at the rear of the machine and the other end to your tap. In situations where you are not sure, let a qualified plumber perform the connection process.
- Water pressure of 0,1-1 MPa from your tap will enable your machine to work more efficiently, (0,1 MPa pressure means water flow of more than 8 litres in 1 minute from a fully opened tap).
- After all connections are completed, check for leakages around the connection joints by turning on your tap completely and seeing if any water escapes.  
Be sure that water inlet hoses are not folded, broken or crushed.
- Mount the water inlet hoses to a 3"/4 geared water tap.



## SECTION-2: INSTALLATION WATER INLET CONNECTION / WATER DISCHARGE CONNECTION

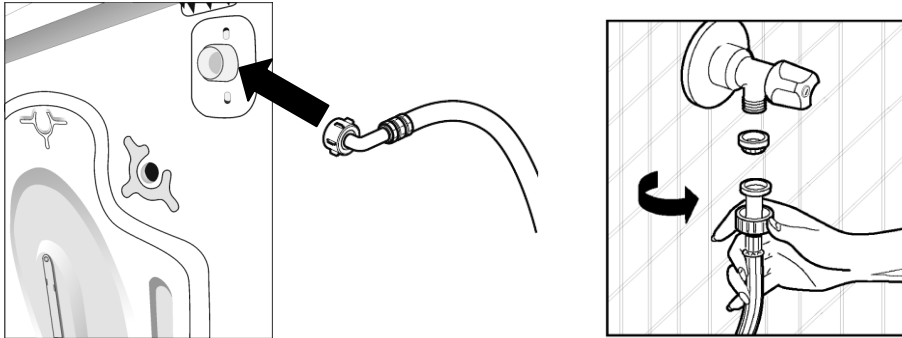

### Water discharge connection

- Be sure that the water inlet hoses are not folded, twisted, crushed or elongated by stretching.
- Water drain hose should be mounted at a height of minimum 60 cm, maximum 100 cm from the ground.
- The end of the water drain hose may be fitted directly to the dirty water outlet hole or a special apparatus mounted on the outlet bracket of the wash-stand.
- Never attempt to extend the water drain hose by adding extra parts.

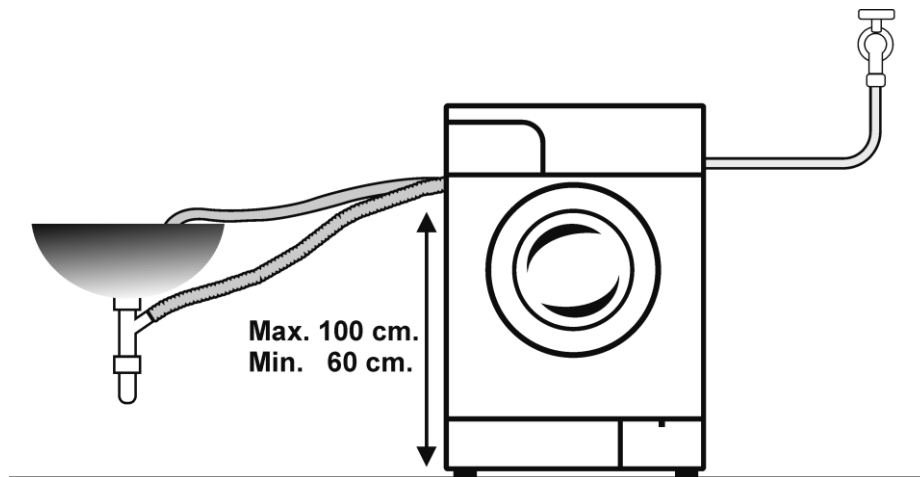

**SECTION-3: TECHNICAL SPECIFICATIONS**





Operating voltage / frequency (V/Hz)	(220-240) V ~/50Hz
Total current (A)	10
Water pressure (Mpa)	Maximum: 1 Mpa Minimum: 0.1 MPa
Total power (W)	2100
Maximum dry laundry capacity (kg)	6
Wringing revolution (rev / min)	1200
Programme number	15
Dimensions (Height x Width x Depth) (mm)	845 x 597 x 527

## SECTION-4: LAUNDRY PREPARATION



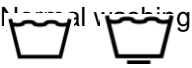
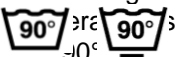

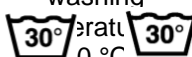









- Separate your clothes according to their types (cotton, synthetic, sensitive, woolen, etc), washing temperatures, dirtiness and colour.
- Never wash your white and coloured clothes together.
- Since your new coloured clothes may shed dye on the first wash, wash them separately.
- Be careful that no metal pieces are found on or in the pockets of your clothes - remove if anything is found.
- Zip and button up your clothes.
- Remove the plastic or metal hooks and laces of curtains or place them inside a washing bag and tie.

**WARNING: Faults that emerge due to the penetration of foreign objects into your machine are not included within the warranty.**

- Reverse textiles such as pants, knitwear, t-shirt and sweat suit.
- Wash socks, handkerchief and suchlike small laundry items in a washing net.

	Maximum washing 	Maximum washing 
Maximum washing 	Handkerchief 	No washing 

## SECTION-4: LAUNDRY PREPARATION

		
Whitening available	No whitening	Ironing temperature is maximum 110°C
		
Ironing temperature is maximum 150°C	Ironing temperature is maximum 200°C	No ironing
		
Dry cleaning available	No dry cleaning	Leave on a flat place
		
Hang when wet	Dry by hanging	Drying by twirling is not allowed
		
Dry cleaning in gas oil, pure alcohol and R113 is allowed	Perchloroethylene R11, R113, Petroleum	Perchloroethylene R11, R113, Gas oil

## SECTION-4: LAUNDRY PREPARATION

- Open the door of your machine.
- Place your laundry in your machine.  
**Note: Maximum loading capacity may vary based on the laundry type you wash, degree of contamination and the programme you have chosen. Do not exceed maximum dry loading capacity indicated in the programme table for washing programmes.**

You can take the following table of weights as an example.

LAUNDRY TYPE	WEIGHT (gr)
Towel	200
Linen	500
Bathrobe	1200
Quilt cover	700
Pillow slip	200
Underwear	100
Tablecloth	250

- Put the laundry in separately.
- Ensure that no laundry is caught between the cover and bellow seal when closing the door of your machine.
- Push the door of your machine until you hear the locking sound – this indicates the door is fully closed.
- Close the door of your machine properly; otherwise your machine will not start the washing operation.

## SECTION-4: LAUNDRY PREPARATION

The amount of detergent you will put in your machine will depend on the following criteria:

- Your detergent utilization will be based on the amount of dirt or the level of stains on your laundry. Do not prewash your less stained laundry items and only put a slight amount of detergent in the 2<sup>nd</sup> compartment of the detergent drawer.
- For very dirty and stained laundry items, select a programme including prewashing, and put  $\frac{1}{4}$  of the normal amount of detergent in the 1<sup>st</sup> compartment of the detergent drawer then put the remaining  $\frac{3}{4}$  of it into the 2<sup>nd</sup> compartment.
- Use detergents produced for automatic washing machines in your machine. The amount of detergent you should use for your laundry is printed on the detergent package.
- The higher the degree of hardness of the water the more detergent you will use.
- The amount of the detergent you will use will increase as the amount of your laundry increases.
- Put the softener in the softener compartment in the detergent drawer. Do not exceed the MAX level. Otherwise, softener will flow into the washing water when flushing through.
- Softeners with a high density should be thinned to a degree before being put in the drawer. This is because high-density softener will clog the flush and avoid the flow of the softener.
- You can use your liquid detergents in all programs without prewashing. For this, fit liquid detergent level plate in the accessories bag into 2<sup>nd</sup> compartment of the detergent drawer and set the amount of liquid detergent according to the levels on this plate. Remember to detach the liquid detergent plate.

## SECTION 5: CONTROL PANEL

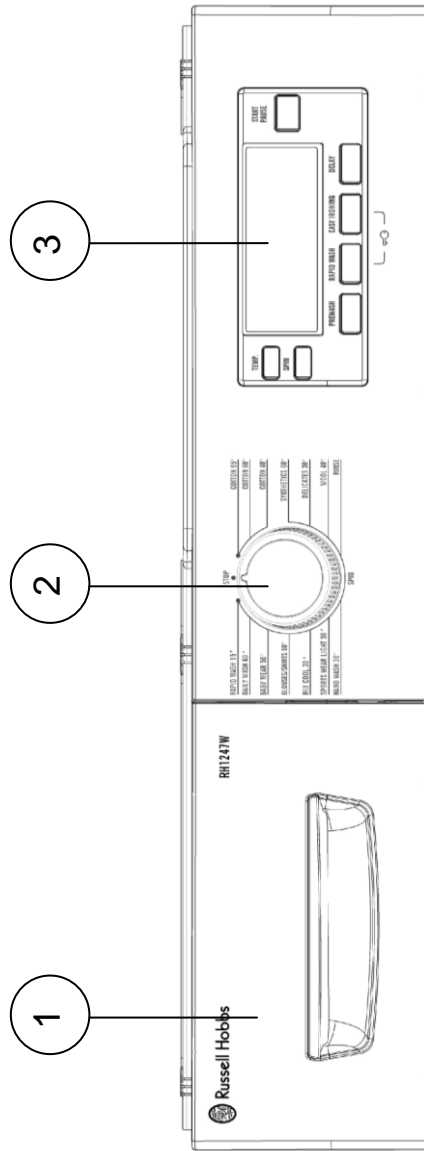

1. Detergent drawer
2. Programme knob
3. Electronic display and auxiliary functions

**SECTION 5: CONTROL PANEL  
DETERGENT DRAWER**

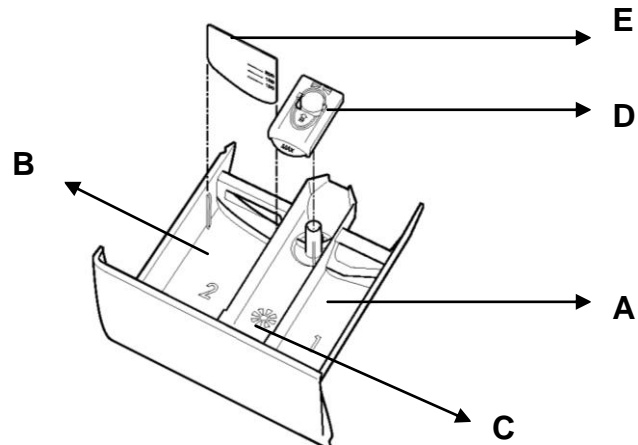

- A. Prewashing compartment
- B. Main washing compartment
- C. Softener compartment
- D. Siphon cover
- E. Liquid level detergent plate



## SECTION 5: CONTROL PANEL PROGRAMME KNOB

You may select the programme you like would like/require to wash your laundry by rotating the programme knob in either direction (clockwise or anti-clockwise). Ensure that the programme knob is exactly on the programme you want to select.

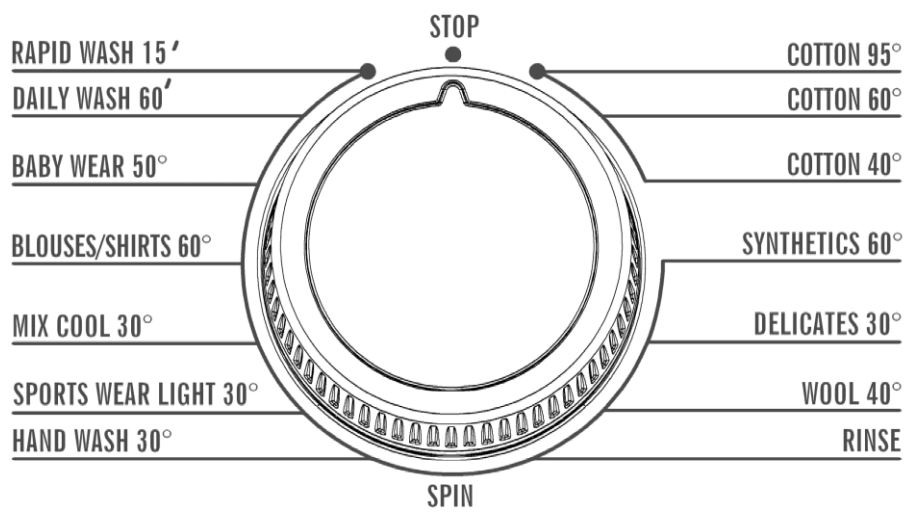

## SECTION 5: CONTROL PANEL ELECTRONIC DISPLAY

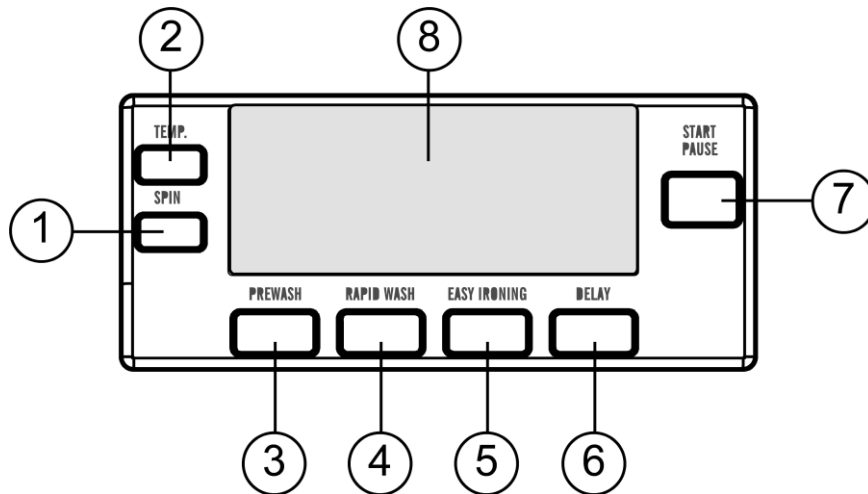

1. Adjusting button for spin speed
2. Adjusting button for temperature of the washing water
3. Auxiliary Prewash function
4. Auxiliary Rapid wash function
5. Auxiliary Easy iron function
6. Auxiliary Delay timer function
7. Start/Pause button
8. Electronic display

On the electronic display, you can view the washing water temperature, spin speed of your machine, the amount of time your machine will continue washing, the auxiliary functions you have selected and whether the door of your machine is locked or not. Furthermore, the electronic display will warn you by means of fault symbols on the display when a fault occurs on your machine and notify you of the completion of the washing programme by displaying the text "END" on the display as soon as the washing programme you have selected has finished.

## SECTION 6: OPERATING YOUR MACHINE

- Plug your machine in.
- Open the water faucet.
- Open the machine door.
- Place your laundry in your machine.
- Push the door of your machine until hearing the locking sound to close it.
- Select the program you require.
- Put detergent and softener in the detergent drawer.

### First washing operation

Some water may be left in your machine due to experiments and tests carried out during production. To dispose of this water, it is recommended to perform the first washing operation in 1<sup>st</sup> programme and without laundry by inserting ½ scale of detergent in 2<sup>nd</sup> compartment of the detergent drawer.

### Selecting programme

Select the convenient programme for your laundry on the programme table.

### Auxiliary Functions

Before starting the programme, you can select an auxiliary function if you so wish.

- Press on the button of the auxiliary function you wish to select.
- If the auxiliary function symbol on the electronic display flashes continuously, the auxiliary function you have selected will be activated.
- If auxiliary function symbol on electronic display blinks, the auxiliary function you have selected will not be activated.

Reason for non-activation:

-The auxiliary function you want to use in the washing programme you have selected is not applicable.

-Your machine has passed the stage during which the auxiliary function you wanted to select could be implemented.

## SECTION 6: OPERATING YOUR MACHINE

### Half-load detection system

Your machine features a half-load detection system. If you only put laundry into the machine that is approximately half or less than half of the maximum laundry capacity stated for your machine, your machine will run so as to save washing time, water consumption and energy in some programmes (Cotton 95°, Cotton 60°, Cotton 40°). When half-load function is active, the machine can complete the programme you have set in a shorter time.

## SECTION 6: OPERATING YOUR MACHINE PROGRAM TABLE

PROGRAMME & PROGRAMME TEMPERATURE (°C)	PROGRAMME DURATION (MIN.)	DETERGENT COMPARTMENT	MAXIMUM AMOUNT OF DRY LAUNDRY (kg)	LAUNDRY TYPE
COTTON 95°	95	2	6	Very dirty cotton and flax textiles. (Underwear, linen, tablecloth(s), towel(s) (maximum 4 kg), bedclothes, etc.
COTTON 60°	60	2	6	Normal dirty cotton and flax textiles. (Underwear, linen, tablecloth(s), towel(s) (maximum 4 kg), bedclothes, etc.
COTTON 40°	40	2	6	Normal dirty colour and flax textiles.
SYNTHETICS 60°	60	2	3	Very dirty synthetic or synthetic-mixed textiles. (Nylon socks, shirts, blouses, synthetic-including trousers etc.)
DELICATES 30°	30	2	2	Less dirty silk-mixed laundries with machine wash labels
WOOL 40°	40	2	2	Woollen laundries with machine wash labels <b>(PLEASE CHECK EACH INDIVIDUAL CLOTHE ITEM'S LABEL – ADJUST TEMPERATURE IF NECESSARY).</b>
RINSE		-	6	If you want to additionally rinse your laundry after a program has finished, you can use this programme for any kind of laundries.
SPIN		-	6	If you want to additionally wring your laundry after a program has finished, you can use this programme for any kind of laundries.
HAND WASH 30°	30	2	2	Sensitive and woollen laundries with non-machine wash labels, that are recommended to be washed by hand.
SPORTS WEAR LIGHT 30°	30	2	3	Sportswear items which are mainly made of special fibers, (in particular a synthetic kind), that the washing label recommends that they should be washed sensitively under a low temperature. In that way, the speciality of sportswear textile, badges, wording, etc should be protect during the washing process.
MIX COOL 30°	30	2	3	Suitable for mixed items of laundry made of cotton and easy-care fabrics sensitive to heat. The program temperature and mechanical agitation is designed to be appropriate to both normal dirty cotton, flax and synthetic based laundry.
SHIRTS/BLOUSES 60°	60	2	3	You can use this program to wash shirts made from cotton, synthetic and synthetic blended fabrics which need to be washed on a lower temperature than synthetics, and gentler than cottons.
BABY WEAR 50°	50	2	3	Baby clothes are delicate and baby skin is really reflective to detergent, this program has an extra rinse with heating which purifies laundry from detergent. Although program has heating step in the main wash, it also applies heating during rinses and it helps to get rid of stains, odors and some microorganisms.
DAILY 60° 60'	60	2	3	You can wash your dirty cotton, colour and flax textiles at 60°C in 60 minutes
SUPER RAPID 30° 15'	30	2	2	You can wash your dirty cotton, colour and flax textiles in 15 minutes. <b>Note: As the washing period is short, a less amount of detergent is required to be used compared to other programmes. The programme period will increase if your machine detects instable loading.</b>

**Note: You can open the door of your machine 2 minutes after the completion of washing operation. (The duration of 2 minutes required to open the door of your machine is not included in the washing period).**

## SECTION 6: OPERATING YOUR MACHINE AUXILIARY FUNCTIONS

### 1. Spin speed selection and auxiliary function of soaking

You can set the spin speed for your laundry via the spin speed setting button.

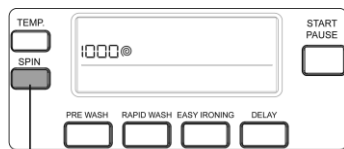

When you select a new programme, the maximum spin speed of the programme you have selected will be shown on the electronic display.

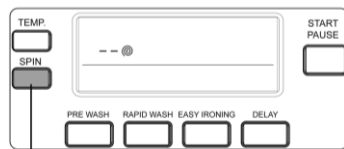

You can gradually reduce the spin speed by pressing the spin speed setting button. The spin function of the program can be cancelled by pressing the spin speed button until (-- ) spin symbols are shown on the electronic display.

If you have missed the spin speed you wanted, you can return to the intended spin speed by continuously pressing the spin setting button.

If you have not unloaded your laundry upon completion of the programme and you don't want them to crease in your machine, you can use the auxiliary soaking function.

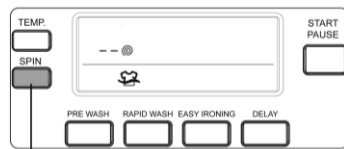

In programmes where the soaking auxiliary function is applicable, it may be activated by pressing the spin speed setting button one more time after the cancel (-- ) spin symbol is shown on the electronic display. You know that the soaking function is activated when the symbol  flashes on electronic display.

## SECTION 6: OPERATING YOUR MACHINE AUXILIARY FUNCTIONS

If this function is selected, your laundry will be soaked in the last rinsing water. When your machine soaks your laundries in the last rinsing water, symbol  will blink on electronic display.

If you want to take your laundry out, press the “Start / Pause” button on. Your machine will empty the water in it and finish the programme without spinning.

If you would like to spin your laundry:

- a) You can select the spin speed by using the spin speed setting button when your machine is soaking your laundry in the latest rinsing water. If you want to take your laundry out, press on “Start / Pause” button. Your machine will empty the water in it and finish the programme after wringing your laundry through the spin speed you have selected.
- b) Switch the programme knob to 0, select the spin programme on the programme knob. You can choose to reduce the spin speed by pressing the spin speed setting button. You can start your machine by pressing on Start/Pause button. Your machine will finish the programme after spinning your laundry in the spin revolution you have selected.

## SECTION 6: OPERATING YOUR MACHINE AUXILIARY FUNCTIONS

### 2. Washing water temperature selection

You can select the washing water temperature with the washing water temperature adjustment button.



Whenever you select a new programme, the maximum washing water temperature is shown on the electronic display.

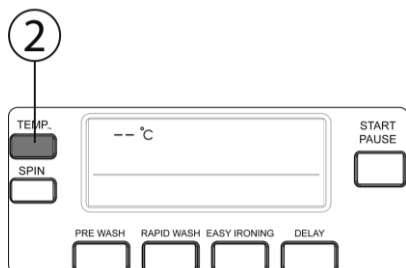

You can gradually decrease the washing water temperature between the maximum temperature and cold washing (--) by pressing washing water temperature adjustment button.

If you have missed the washing water temperature you wanted, you can return to the intended temperature by continuously pressing the washing water temperature adjustment button.



## SECTION 6: OPERATING YOUR MACHINE AUXILIARY FUNCTIONS

### 3. Auxiliary function prewash

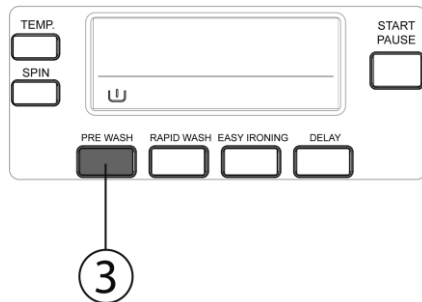

You can give your very dirty laundry a prewash prior to the main wash by using this auxiliary function. When using this function, you should put detergent in the front washing compartment of the detergent drawer.

### 4. Auxiliary function for rapid wash

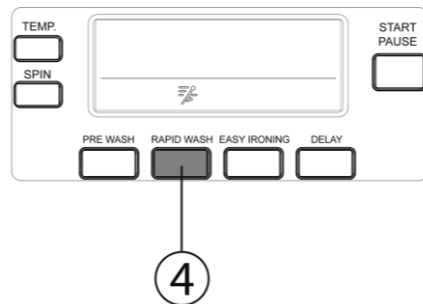

This auxiliary function will enable the washing duration of your less dirty laundry to be shortened. If you put laundry in that only makes up half or less than half of the laundry capacity of the washing programme you have selected in your machine, your machine will automatically detect this due to the 'Half-load' detection

system, and the programme you have selected will wash your laundry in a shorter time to consume less energy and water. If your machine detects a half load, the symbol  will automatically flash on the electronic display. To cancel it, press the rapid wash auxiliary function button once. However, the selection of the rapid wash auxiliary function of quick washing will not be possible if you have selected the main rapid wash programme with the programme knob.

### 5. Auxiliary function for easy ironing

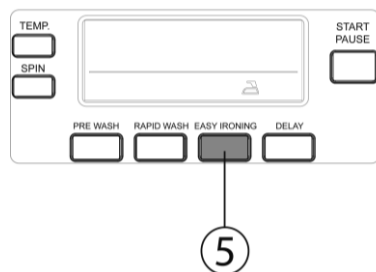

Your laundry will be less creased if the easy ironing auxiliary function is pressed/selected.

## SECTION 6: OPERATING YOUR MACHINE AUXILIARY FUNCTIONS

### 6. Auxiliary function for delay timer

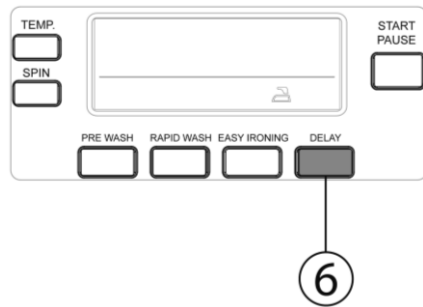

By using this auxiliary function, you can delay the start of your washing programme by 30 minutes and up to 23 hours.

To use the delay timer auxiliary function:

- Press time delay button once.
- "0.5h" will appear on the display.
- Press the time delay button until the time of which you want the washing programme to be delayed by is shown on the electronic display.
- To activate the time delay of the programme you have selected, you should press the "Start/Pause" button and the time delay will start to count down.

The time Intervals of the delay timer is 30 minutes for the first 2 hours, thereafter it is 1 hour for 3 hours to 23 hours.

If you have missed the time delay you wanted, you can go back to the time desired by continuously pressing the delay timer button.

If you want to cancel the delay timer, you need to press and hold the delay timer button for 2 – 4 seconds.

To run the delay timer function, your machine needs to be operated by pressing on Start/Pause button. As soon as you start your machine, the count down process will start on the electronic display based on the delay period you have selected.

## SECTION 6: OPERATING YOUR MACHINE AUXILIARY FUNCTIONS

### 7. Anti-Allergic auxiliary function

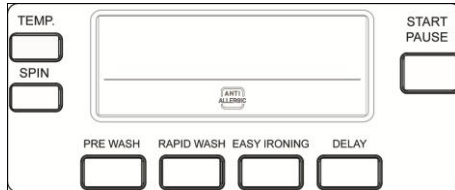

In the programmes where this auxiliary function is active, your machine will perform an extra rinsing operation on your laundry prior to the last rinsing operation.

**Note:** Anti-Allergic auxiliary function is selected automatically only in Baby wear programme.

## SECTION 6: OPERATING YOUR MACHINE STARTING THE PROGRAMME

### Start/Pause button

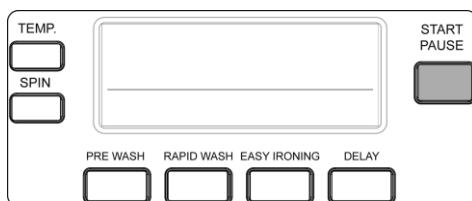

By pressing on Start/Pause button, you may start the programme you have selected, suspend a running programme. If you switch your machine to pause mode, electronic display will blink.

When you start your machine, the following symbols for the programmes you have selected will be available on the electronic display.

- Temperature of washing water
- Spin speed
- Symbols of auxiliary functions (if you have selected)
- Programme ending time or programme delay time based on your selection
- Open or locked door symbol

**Note:** Symbol for open door flashing on electronic display will go off and symbol for locked door will flash approximately 1 minute after you start your machine by pressing the Start/pause button.



Open door



Locked door

## SECTION 6: OPERATING YOUR MACHINE ADDING/REMOVING LAUNDRY

### Adding/Removing laundry from the machine

If you want to add or remove laundry when your machine is running:

- Switch your machine to the pause mode by pressing on Start/Pause button.

- After a while, the symbol  will be shown on the electronic display and this means that the door of your machine can now be opened.

- When you see the symbol  on the electronic display, you can either add or remove laundry after opening the machine door.

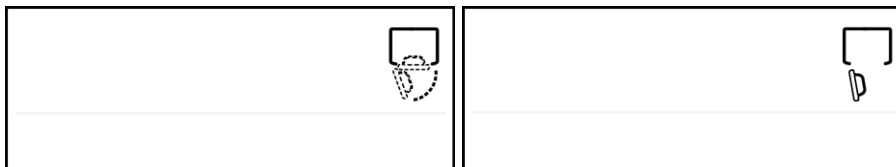

**Note:** If symbol  blinks on the electronic display, it means that you cannot add or remove laundry as your machine has passed the steps in question.

- When you have added or removed the laundry, close the door of your machine and press on Start/Pause button.

- Your machine will continue to wash after locking the door of your machine.

- The symbol  will flash on the electronic display.

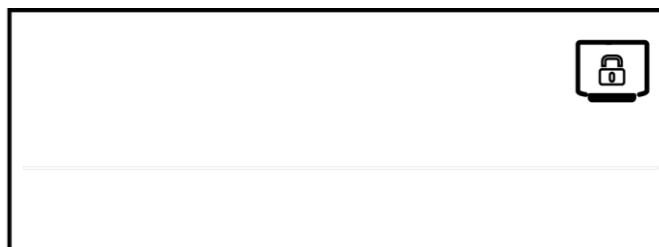



## SECTION 6: OPERATING YOUR MACHINE

### CHILD LOCK

#### Child lock

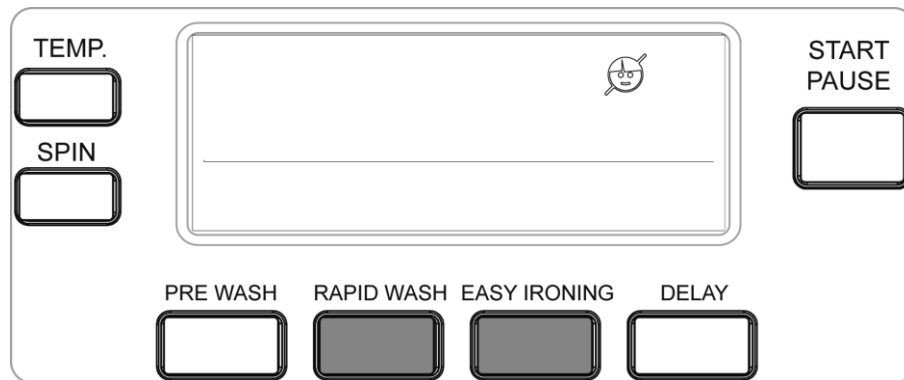
To avoid programme flow from being affected if programme knobs are pressed or programme knob is turned when performing washing operation in your machine, a child lock is available. The Child lock will be activated when both the rapid wash and easy ironing auxiliary functions are pressed at the same time for 3 seconds or longer.



The symbol  will flash on the electronic display when activated.

If any button is pressed while child lock is active, the symbol  will blink on the electronic display.

When any of the programmes are running and the child lock is active, if another programme is selected after programme knob is switched to the Stop position, the programme already running will continue.

To deactivate the Child Lock, both the rapid wash and easy ironing auxiliary functions should be pressed at the same time for 3 seconds or longer. When Child Lock is deactivated, symbol  on the electronic display will go off.

## **SECTION 6: OPERATING YOUR MACHINE CANCELLING PROGRAMME**

### **Cancelling programme**

If you want to cancel any programme running:

- Switch the programme knob to Stop.
- Your machine will stop the washing operation and the programme will be cancelled.
- To get rid of the water accumulated in the machine switch the programme knob to any programme.
- Your machine will perform the necessary discharge operation and cancel the programme.
- You can run your machine by selecting a new programme.

## SECTION 6: OPERATING YOUR MACHINE FINISHING PROGRAMME

### Finishing programme

- Your machine will stop by itself as soon as the programme you have selected finishes.
- The text "END" will flash on the electronic display.

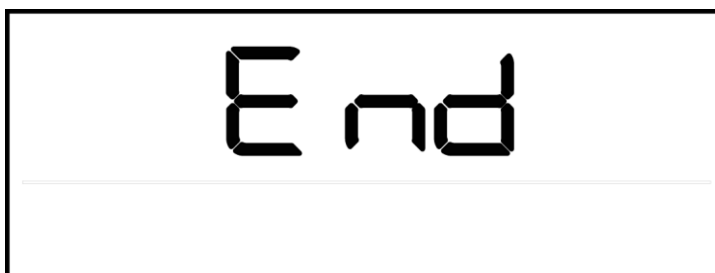

**Note:** Within 2 minutes of the programme finishing, your machine will remove the "End" text from the electronic display to save energy. It will re-flash when any of the auxiliary function buttons are pressed.

- If you see that the symbol  indicating that the door can be opened flashes on the electronic display, you can open the door of your machine and remove the laundry.

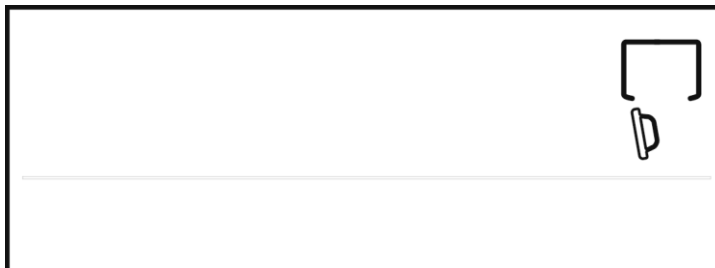

- Leave the door of your machine open to allow the inner part of your machine to dry after removing your laundry.
- Switch the programme knob to Stop.
- Unplug your machine.
- Turn the water faucet off.



## SECTION 7: ELECTRONIC DISPLAY WARNING SYMBOLS WARNING OF WATER CUT-OFF / LOW MAINS WATER PRESSURE

If the symbol  flashes on the electronic display:

- Water faucet may be closed. Check.
- Mains water may be cut-off. Check. If so, switch the programme knob to position 0. You can select a programme and run your machine after the mains water is supplied.
- Mains water pressure may be low. Check.
- Water inlet hose may be twisted. Check.
- Water inlet hose may be clogged. Clean water inlet hose filters. (\*)
- Valve inlet filter may be clogged. Clean the valve inlet filters. (\*)

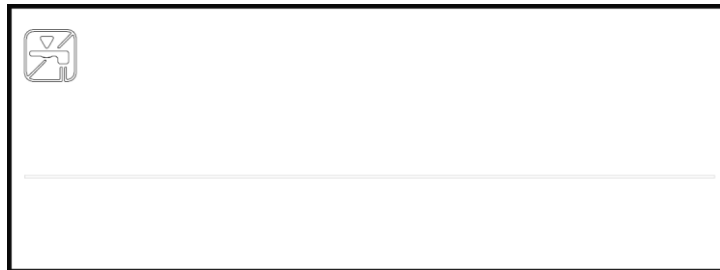

(\*) See the chapter regarding maintenance and cleaning of your machine.

## SECTION 7: ELECTRONIC DISPLAY WARNING SYMBOLS WARNING OF CLOGGED PUMP FILTER

If the symbol  flashes on the electronic display:

- Pump filter may be clogged. Clean the pump filter. (\*)
- Discharging hose may be clogged or twisted. Check the discharging hose.

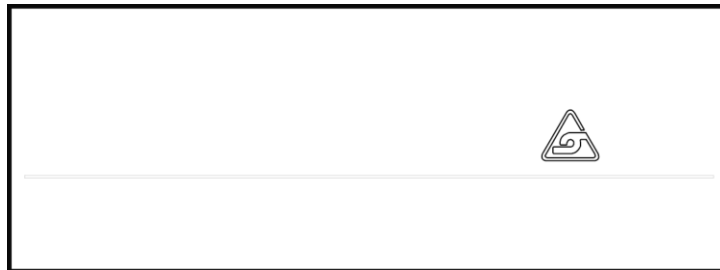

(\*) See the chapter regarding maintenance and cleaning of your machine.

## SECTION 8: MAINTENANCE AND CLEANING OF YOUR MACHINE



- Unplug your machine.
- Turn the water faucet off.

### WATER INLET FILTERS

Filters to avoid dirt and foreign substances in the water from penetrating into the machine are available both on the side of faucet and on the ends of water valves along the water inlet hose of your machine. If your machine cannot intake sufficient amount of water despite water faucet being open, these filters should be cleaned.

- Detach the water inlet hoses.
- Remove the filters on water inlet valves using pliers and then clean it with a brush in water.
- Disassemble the filters on the side of faucet side of water inlet hoses manually and clean it.
- Having the filters cleaned, you can fit them in the same way reversely.



**CAUTION:** Filters of water inlet valves may be clogged due to contaminated water faucet or lack of necessary maintenance or valves may be broken down, causing water leaking into your machine continuously. **Breakdowns that may arise because of these reasons are out of scope of warranty.**

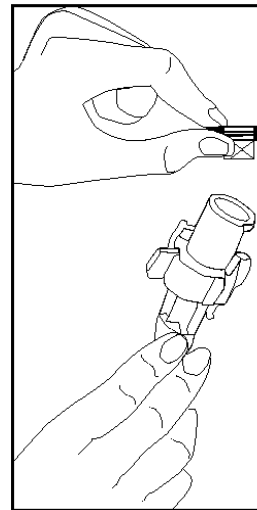
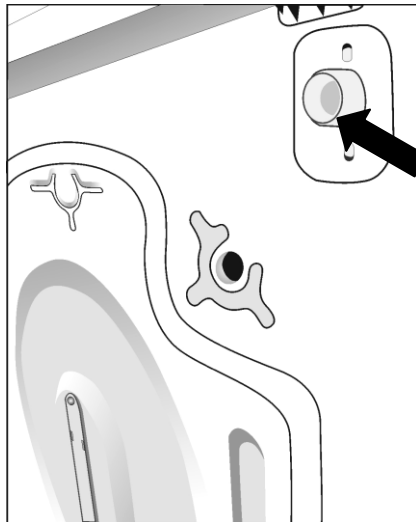

## SECTION 8: MAINTENANCE AND CLEANING OF YOUR MACHINE / PUMP FILTER

A filter system is available which avoids threads from your laundry and tiny materials from entering into the pump during the water discharging operation carried out by your machine after completing washing. This prolongs the lifecycle of your pump. It is recommended that you clean your pump filter once in 2 months. To clean pump filter:

- Depress the lug downwardly to uncover the pump section of the toe board and pull it towards yourself and extract it.

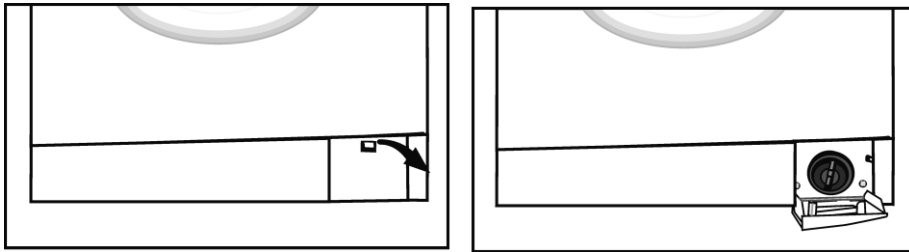

- Before opening the filter cover, settle a vessel in front of the filter cover to prevent the water remaining in the machine from flowing onto the ground.

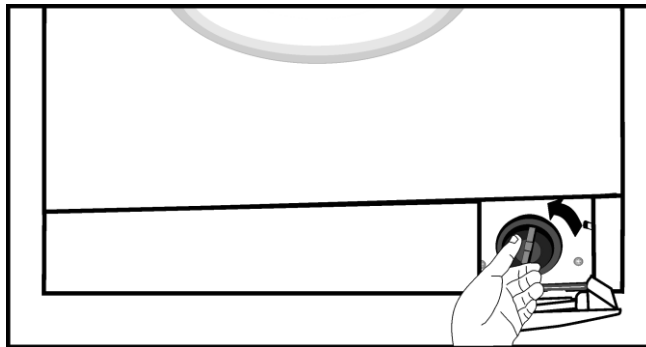

- Loosen the filter cover in counter-clockwise and then empty water.
- Clean the foreign materials in the filter.
- Check whether the pump rotates with your hands.

## SECTION 8: MAINTENANCE AND CLEANING OF YOUR MACHINE / PUMP FILTER

- After cleaning the filter, fit the filter cover by rotating it clockwise.
- Fit the pump section of the toe board.
- Remember that water will leak if you do not fit the filter cover properly.
- You can use the pump section of the toe board for discharging a slight amount of water remaining in the pump of your machine.



### **WARNING!**

As water in the pump may be hot, wait until it cools down.

## SECTION 8: MAINTENANCE AND CLEANING OF YOUR MACHINE / DETERGENT DRAWER

Your detergents may deposit residue in detergent drawer over time. To clean the residue formed, disassemble the detergent drawer regularly. To eject the detergent drawer:

- Pull the detergent drawer out fully.

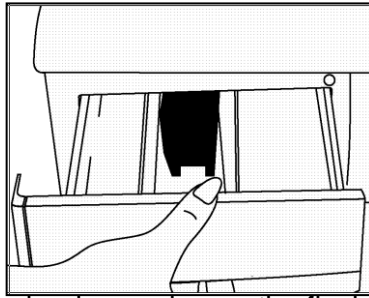

- Keep on pulling by depressing on the flush cover in the detergent drawer already being pulled up to the end and then unsettle the detergent drawer.

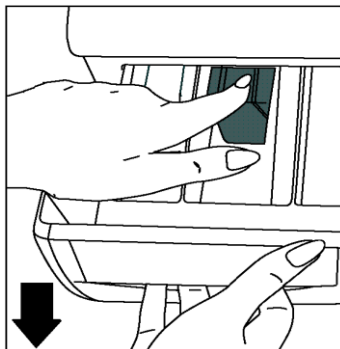

- Flush it using a brush.
- Collect residues in the housing of the detergent drawer without dropping them inside the machine.
- To assemble the detergent drawer after drying it using a towel or dry cloth, reset the detergent drawer by depressing on the flush cover and fit it by pushing forward.
- **Do not wash your detergent drawer in a dishwasher.**

## SECTION 8: MAINTENANCE AND CLEANING OF YOUR MACHINE / SIPHON PLUG / BODY / DRUM

### Siphon plug

Disassemble the detergent drawer. Disassemble the flush stopper and clean the softener residues completely. Refit the flush stopper after cleaning it. Check whether it has settled properly.

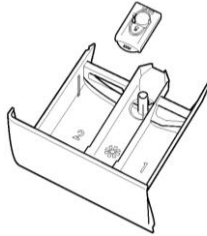

### Body

Clean the outer body of your machine with warm water and a non-flammable cleaning agent that will not abrade the body of your machine. After rinsing with some water, dry it using a soft and dry cloth.

### Drum

Do not leave metallic objects such as needles, paper clips, coins, etc. in your machine. These objects will lead to formation of rust stains in the drum. To clean such rust stains, use a non-chlorine cleaning agent and follow the instructions of the manufacturers of the cleaning agent. Never use wire wool or similar hard objects for cleaning rust stains.

## SECTION 9: PRACTICAL INFORMATION



**Alcoholic drinks:** Spotted area should initially be washed using cold water, and then be wiped with glycerine and water and rinsed with vinegar-mixed water.



**Shoe shine:** Spot should be rubbed out gently without damaging the cloth and be scrubbed and rinsed with detergent. If not removed, it should be scrubbed using the mixture obtained by adding 1 scale of alcohol (96°) into 2 scales of water, and then be washed with warm water.



**Tea and coffee:** Stretch the spotted area of your laundry over an opening of a container, and pour over as much hot water that the type of your laundry can resist. If the type of your laundry permits it, wash with bleach.



**Chocolate and cocoa:** After submerging you laundry in cold water and rubbing it using soap or detergent, wash it in the temperature wash that the fabric type of your laundry can resist. In case the oil stain is still visible, wipe with oxygen water (3%).



**Tomato paste:** After rubbing out the dried substances without damaging your laundry, submerge it in water for 30 minutes, and then scrub and wash it with detergent.



**Bouillon-egg:** Remove dried spot residues on your laundry, and then wipe it with a sponge or soft cloth that has been submerged in cold water. Scrub with detergent, wash with diluted bleach.



**Gres ve yağ lekesi:** Firstly, wipe the residues. Scrub the spot with detergent and wash it with warm soapy water.



**Mustard:** Apply glycerine on spotted area. Scrub with detergent and wash. If spot cannot be removed, wipe with alcohol. (For synthetic and colour fabrics, a mixture of 1 scale of alcohol and 2 scales of water should be used)



## SECTION 9: PRACTICAL INFORMATION



**Blood stain:** Submerge your laundry in cold water for 30 minutes. If the stain is not removed, then submerge in a mixture of water and ammoniac (3 spoons of ammoniac in 4 litres of water) for 30 minutes.



**Cream, ice cream and milk:** Submerge your laundry in cold water and scrub the spotted area with detergent. If the spot is not removed, apply bleach to the extent suitable for your laundry. (Do not use bleach on coloured laundry.)



**Muff:** Muff stains should be cleaned as soon as possible. Stain should be washed with detergent water, nevertheless if it cannot be removed, it should be wiped with oxygen water (3%).



**Ink:** Subject the spotted area to running water and wait until the flow of inked water ends. Then, wipe it with lemon water and detergent, and wash it after 5 minutes.



**Fruit:** Stretch the spotted area of your laundry over the opening of a container, and pour cold water on it. Do not pour hot water on the spot. Wipe with cold water and apply glycerine. Allow 1-2 hours, wipe with a few drops of white vinegar, and rinse it.



**Grass stain:** Wipe the stained part with detergent. If your type of your cloth permits it, wash it with bleach. Wipe your woollen laundry with alcohol. (For colour fabrics, a mixture of 1 scale of pure alcohol and 2 scales of water)



**Oil paint:** Spot should be removed by applying thinner before drying. Then, it should be wiped with detergent and washed.



**Burn stain:** If your laundry is suitable for applying bleach, you can add bleach into the washing water. For woollen fabrics, a cloth previously submerged in oxygen water should be covered over the stain, and it should be ironed after putting a dry cloth on this cloth. It should be washed after being rinsed properly.

## SECTION 10: TROUBLESHOOTING

All repairing operations required for your machine should be carried out by our authorised service. If your machine requires a repair or if you cannot remove the fault by the help of the information provided as follows:

- Unplug your machine.
- Turn the water faucet off.
- Contact the nearest authorised service.

FAULT	POSSIBLE CAUSE	REMOVING METHODS
Your machine does not start.	It is not plugged in.	Plug it in.
	Fuses out of order.	Replace the fuses.
	Electricity cut-off.	Check mains power.
	Start/pause button not pressed.	Press on start/pause button.
	Programme knob on position 0.	Switch the programme knob to the desired position.
	The machine door is not completely closed.	Close the machine door.
Your machine does not intake water.	Your faucet is turned off.	Turn your faucet on.
	Water inlet hose may be twisted.	Check water inlet hose.
	Water inlet hose clogged.	Clean water inlet hose filters. (*)
	Valve inlet filter clogged.	Clean the valve inlet filters. (*)
	The machine door is not completely closed.	Close the machine door.

(\*) See the chapter regarding maintenance and cleaning of your machine.

## SECTION 10: TROUBLESHOOTING

FAULT	POSSIBLE CAUSE	REMOVING METHODS
Your machine does not discharge water.	Discharging hose clogged or twisted.	Check the discharging hose.
	Pump filter clogged.	Clean the pump filter. (*)
	Laundry settled in the machine unevenly.	Spread your laundries in the machine properly and evenly.
Your machine vibrates.	The stays of your machine not adjusted.	Adjust the stays of your machine. (**)
	Safety assembly fitted for transport not disassembled.	Disassemble the safety assembly of your machine. (**)
	Less amount of laundry in the appliance.	This will not block operation of your machine.
	Your machine overloaded with laundry or laundry settled unevenly.	Do not put in laundry more than the amount recommended and settle the laundry in the machine evenly.
	Your machine rests on a hard surface.	Prevent your machine from resting on hard surfaces. When settling your machine, leave 2 cm space between it and wall or hard surfaces.

(\*) See the chapter regarding maintenance and cleaning of your machine.

(\*\*) See the chapter regarding installation of your machine.

## SECTION 10: TROUBLESHOOTING

FAULT	POSSIBLE CAUSE	REMOVING METHODS
Excessive foam is formed in the detergent drawer.	Excessive amount of detergent used.	Press on Start/Pause button. To eliminate foam formation, mix a spoon of softener with half litre of water, and pour the mixture in the detergent drawer. After 5-10 minutes, press on Start/Pause button again. For next washing operation, decide the dose of detergent as required.
	Wrong detergent used.	Use detergents produced only for automatic washing machines in your machine.
Unsatisfactory washing result.	The dirtiness of your laundry does not match the programme you have chosen.	Select the programme appropriate for correct dirtiness of your laundry. (see programme table)
	Amount of detergent used insufficient.	Adjust the amount of detergent based on the dirt level of your laundry.
	Laundry in excess of maximum capacity put in your machine.	Load your machine with laundry, amount of which should not exceed maximum laundry capacity

## SECTION 10: TROUBLESHOOTING

FAULT	POSSIBLE CAUSE	REMOVING METHODS
Unsatisfactory washing result.	Water being hard.	Adjust the amount of detergent based on the instructions of the detergent manufacturer.
	Laundry distributed in your machine unevenly.	Spread your laundries in the machine properly and evenly.
As soon as the machine is loaded with water, water discharges.	The end of water discharging hose is too low for the machine.	Set the water discharging hose on appropriate height. (**)
No water appears in the drum during washing.	No fault. Water in the non-visible part of the drum.	-
Laundry has detergent residues on it.	Non-dissolving particles of some detergents may adhere to your laundries as white spots.	Perform an extra rinsing by setting your machine to "Rinsing" programme, or clean the spots using a brush after your laundry dries.
Grey spots appear on the laundry.	The reason for this spots may be oil, cream or ointment.	Use the maximum amount of detergent instructed by the detergent manufacturer in the next washing operation.

(\*\*) See the chapter regarding installation of your machine.

## SECTION 10: TROUBLESHOOTING

FAULT	POSSIBLE CAUSE	REMOVING METHODS
Wringing operation is not performed or runs late.	No fault. Unbalanced load control system has been activated.	Unbalanced load control system will try to spread your laundries evenly. Wringing operation will start after spreading your laundry. Put your laundry in the machine evenly in the next washing operation.



## SECTION 11: AUTOMATIC FAULT WARNINGS AND WHAT TO BE DONE

Your machine is equipped with systems that continually self-check during washing operations and then take the necessary precautions and warn you in case of any breakdown.

TROUBLE CODE	POSSIBLE FAULT	WHAT TO DO
E01	The door of your machine is left open.	Close the machine door. If your machine persists to indicate fault, turn off your machine, unplug it and contact the nearest authorised service immediately.
E03	Pump is faulty or pump filter is clogged or electrical connection of the pump is faulty.	Clean the pump filter. If the problem persists, contact the nearest authorised service. (*)
E04	Your machine has an excessive amount of water.	Your machine will discharge water by itself. After the discharging operation, turn off your machine and unplug it. Turn off your faucet and contact the nearest authorised service.

(\*) See the chapter regarding maintenance and cleaning of your machine.

**SECTION 11: AUTOMATIC FAULT WARNINGS AND WHAT TO BE DONE**

TROUBLE CODE	POSSIBLE FAULT	WHAT TO DO
	<p>Water cut-off or low mains water pressure..</p>	<ul style="list-style-type: none"> <li>- Water faucet may be closed. Check.</li> <li>- Mains water may be cut-off. Check.</li> <li>- If so, switch the programme knob to position 0. You can select a programme and run your machine after the mains water is supplied.</li> <li>- Mains water pressure may be low. Check.</li> <li>- Water inlet hose may be twisted. Check.</li> <li>- Water inlet hose may be clogged.</li> <li>- Clean water inlet hose filters. (*)</li> <li>- Valve inlet filter may be clogged.</li> <li>- Clean the valve inlet filters. (*)</li> </ul> <p>If the problem persists, unplug your machine, turn off your faucet and contact the nearest authorised service.</p>
	<p>Pump is faulty or pump filter is clogged or electrical connection of the pump is faulty.</p>	<ul style="list-style-type: none"> <li>- Pump filter may be clogged. Clean the pump filter. (*)</li> <li>- Discharging hose may be clogged or twisted. Check the discharging hose.</li> </ul> <p>If the problem persists, contact the nearest authorised service. (*)</p>



## **SECTION 12: DESCRIBING SAVING ENERGY**

Energy and water consumption may vary based on water pressure, water hardness, water temperature, ambient temperature, laundry amount, additional function selection, and voltage fluctuations.

It will reduce energy and water consumption to use your machine with the laundry capacity proposed for the selected programme, wash your less dirty or daily laundry in short programmes, carry out cleaning and maintenance periodically, use your machine at the convenient time intervals specified by electricity vendor.

For Customer Services &  
Warranty Information please call  
**0845 683 8717**

Opening times:  
Monday - Friday 8am until 8pm  
Saturday & Sunday 10am until 4pm

Customer Service Department  
Picktree Court  
Picktree Lane  
Chester-le-Street  
Co Durham  
DH3 3SY

Revision 1



This symbol is known as the 'Crossed-out wheellie bin Symbol'. When this symbol is marked on a product/batteries, it means that the product/batteries should not be disposed of with your general household waste. Only discard electrical/electronic/battery items in separate collection schemes, which cater for the recovery and recycling of materials contained within. Your co-operation is vital to make sure the success of these schemes and for the protection of the environment. For your nearest disposal facility, visit [www.recycle-more.co.uk](http://www.recycle-more.co.uk) or ask in store for details.

We reserve the right, due to possible changes to product design, to alter the instruction manual without prior notice.

52035051